

Koshy, C.S., Flores, P., Lankarani, H.M., Study of the effect of contact force model on the dynamic response of mechanical systems with dry clearance joints: computational and experimental approaches. *Nonlinear Dynamics*, Vol. 73(1-2), pp. 325-338, 2013

Study of the effect of contact force model on the dynamic response of mechanical systems with dry clearance joints: computational and experimental approaches

C.S. Koshy¹, P. Flores^{2,*}, H.M. Lankarani¹

¹ Department of Mechanical Engineering, Wichita State University
Wichita, KS 67260-133, USA

² CT2M/Centro de Tecnologias Mecânicas e de Materiais,
Departamento de Engenharia Mecânica, Universidade do Minho,
Campus de Azurém, 4800-058 Guimarães, Portugal

Abstract

The main objective of this work is to present a computational and experimental study on the contact forces developed in revolute clearance joints. For this purpose, a well-known slider-crank mechanism with a revolute clearance joint between the connecting rod and slider is utilized. The intra-joint contact forces that generated at this clearance joints are computed by considered several different elastic and dissipative approaches, namely those based on the Hertz contact theory and the ESDU tribology-based for cylindrical contacts, along with a hysteresis-type dissipative damping. The normal contact force is augmented with the dry Coulomb's friction force. In addition, an experimental apparatus is use to obtained some experimental data in order to verify and validate the computational models. From the outcomes reported in this paper, it is concluded that the selection of the appropriate contact force model with proper dissipative damping plays a significant role in the dynamic response of mechanical systems involving contact events at low or moderate impact velocities.

Keywords: Clearance joints, Elastic force models, Dissipative force models, Experimental approach, Multibody Dynamics

* Corresponding author, Tel: + 351 253510220, Fax: +351 253516007, E-mail: pflores@dem.uminho.pt

1. Introduction

The problem of modeling joints with clearance in the context of multibody dynamics has been the subject of many investigations over the last few decades [1-20]. A comprehensive literature review on the topic of clearance joints was carried out by Haines [21] and more recently by Flores [22]. The literature indicates that most of this research is limited to theoretical modeling or computational studies. Therefore, it is not surprising that the literature reporting on experimental studies on mechanical systems with clearance joints is confined only to a few sources. Soong and Thompson [23] presented a theoretical and experimental investigation of the dynamic response of a slider-crank mechanism with a revolute clearance joint, where the slider and the connecting rod accelerations were quantified by using accelerometers. A similar slider-crank mechanism was experimentally studied by Lankarani and his co-workers [24], which was considered to analyze the influence of input crank speed and clearance size on the system's dynamic response. It was shown that the maximum amplitude of the impact acceleration increased with clearance size and the crank speed. In particular, for low crank speeds the apparent gross motion characteristics of the slider-crank mechanism remained unchanged. For high frequencies and larger clearances, however, the dynamic response was shown to be significantly altered. This work was subsequently extended by Flores [25] and Koshy [26]. The reported results clearly demonstrated the severe dynamic behavior in a clearance joint and provided a qualitative measure of the associated fatigue and wear phenomena in which the components must be reliably operate. More recently, Khemili and Romdhane [27] studied the dynamic behavior of a planar flexible slider-crank mechanism with clearance joints using computational and experimental tests. Erkaya and Uzmay [28] presented a quite interesting work, in which an extensive experimental data of a slider-crank mechanism with clearance joints was discussed. These last two works consider a similar test rig, where the system describes the motion in the vertical plane. Flores et al. [29] performed a combined numerical and experimental study on the dynamic response of a slider-crank mechanism with revolute clearance joints with the purpose of providing an experimental verification and validation of the predictive capabilities of the multibody clearance joint models. This study was supported in an experimental test rig, which consisted of a slider-crank mechanism with an adjustable radial clearance at the revolute joint between the slider and the connecting rod. The maximum slider acceleration, associated with the impact acceleration, was used as a measure of the impact severity. The correlation between the numerical and experimental results was presented leading to the validation of the models for the clearance joints.

It is well known that the constitutive contact force law utilized to describe contact-impact events plays a crucial role in predicting the dynamic response of mechanical systems and simulation of the engineering applications. Thus, this paper studies the influence of the use of different contact force models with dissipative damping on the dynamic response of mechanical including dry revolute clearance joints. In the sequel of this process, the fundamental characteristics of the most popular elastic and dissipative contact force models are revisited, in particular those based on the Hertz's law, augmented with a hysteresis damping term [30]. A computational slider-crank multibody model with a revolute clearance joint between the connecting rod and slider is developed and utilized to test the different contact force models. The procedure is performed using the commercial MSC.ADAMS software, in which the several constitutive laws are incorporated to compute the intra-joint contact forces developed at the clearance joint. In order to verify and validate this computational approach, the outcomes are compared with those obtained experimentally. From the results obtained on the dynamic behavior of system with clearance joints, the importance of the constitutive law selected to compute the contact forces is quantified.

The remaining of this paper is organized as follows. Section 2 deals with the description of the conservative and dissipative contact force models utilized in the present work. In Section 3, a full characterization of the computational multibody model of the slider-crank mechanism with a revolute clearance joint is presented. This task has been performed using the [MSC.ADAMS software](#). Section 4 presents the experimental test rig apparatus used to obtain the experimental data. The computational and experimental results are then presented and discussed in Section 5. Finally, in the last section, the main conclusions from this study are drawn, in the light of the assumptions and procedures underpinning this research.

2. Contact force models utilized

In order to efficiently and accurately evaluate the contact forces developed between the bearing and journal, in revolute clearance joints, special attention must be given to the numerical description of the constitutive law selected for the contact force model [31]. Information on the impact velocity, material properties of the colliding bodies and geometry characteristics of the surfaces in contact must be included into the force contact model. These characteristics are observed with a continuous contact force, in which the local deformation and contact force are considered as continuous functions [32]. Furthermore, it is important that the contact force model can add to the stable

integration of the multibody systems equation of motion. Thus, the main purpose of the section is to present a simple review of the constitutive laws utilized in this work.

The simplest elastic contact force model is represented by a linear spring element, in which the spring embodies the elasticity of the contacting surfaces. This linear contact force model, also known as Hooke's law, can be expressed as [33]

$$F_N = k\delta \quad (1)$$

where F_N denotes the normal contact force, k is the spring stiffness and δ represents the relative penetration or deformation between the colliding bodies. [The spring stiffness of the Hooke contact force model can be evaluated by using analytical expressions for simple cases, obtained by means of finite element method or determined through experimental tests performed within the linear elastic domain \[30\].](#) In turn, the penetration is determined from the relative position of the contacting bodies.

One primary weakness associated with this contact force model deals with the quantification of the spring constant, which depends on the geometric and material characteristics of the contacting bodies. Furthermore, the assumption of a linear relation between the penetration and the contact force is at best a rough approximation, because the contact force is affected by the shape, surface conditions and mechanical properties of the contacting bodies, all of which suggest a more complex relation. In addition, the contact force model given by Eq. (1) does not account for the energy loss during an impact event.

The most popular contact force model for representing the collision between two spheres of isotropic materials is based on the work by Hertz, utilizing the theory of elasticity [34]. The Hertz contact theory is restricted to frictionless surfaces and perfectly elastic solids. The Hertz law relates the contact force with a nonlinear power function of penetration and is expressed as [35]

$$F_N = K\delta^n \quad (2)$$

where K is a generalized stiffness parameter and δ has the same meaning as in Eq. (1). The exponent n is equal to 3/2 for the case where there is a parabolic distribution of contact stresses, as in the original work by Hertz [36]. For materials such as glass or polymer, the value of the exponent n can be either higher or lower, leading to a convenient contact force expression which is based on experimental work, but that should not be confused with the Hertz theory [37-40].

One advantage of the Hertz contact law is that it considers the geometric and material characteristics of the contacting surfaces, which are of paramount importance

in the contact dynamic responses. For instance, for two spheres of isotropic materials in contact, the generalized stiffness parameter is a function of the radii of the sphere i and j (R_i and R_j) and the material properties as [41]

$$K = \frac{4}{3(\sigma_i + \sigma_j)} \sqrt{\frac{R_i R_j}{R_i + R_j}} \quad (3)$$

in which the material parameters σ_i and σ_j are given by

$$\sigma_l = \frac{1 - \nu_l^2}{E_l}, \quad (l=i, j) \quad (4)$$

and the quantities ν_l and E_l are the Poisson's ratio and the Young's modulus associated with each sphere, respectively. It is important to note that, by definition, the radius is negative for concave surfaces (such as for the journal element) and positive for convex surfaces (such as for the bearing element) [42].

After an extensive review of the Hertz contact theory, Goldsmith [41] concluded that the Hertz theory provides a good approach of the contact process if the materials involved are hard and the initial impact velocity is low, that is, impacts slow enough that the bodies are deformed imperceptibly only. It is apparent that the Hertz contact law given by Eq. (2) is limited to contacts with elastic deformations and does not include energy dissipation. This contact force model represents the contact process as a nonlinear spring along the direction of collision. The advantages of the Hertz model relative to the Hooke's law reside on its physical meaning represented by both its nonlinearity and by its relation between the generalized stiffness and geometry and material properties of the contacting surfaces. Although the Hertz law is based on the elasticity theory, some studies have been performed to extend its application to include the energy dissipation. In fact, the process of energy transfer is an extremely complex task of modeling contact events. When an elastic body is subjected to cyclic loads, the energy loss due to internal damping causes a hysteresis loop in the force-penetration diagram, which corresponds to energy dissipation.

Hunt and Crossley [43] represented the contact force by the Hertz force-penetration law together with a non-linear viscoelastic element. Based on Hunt and Crossley's work, Lankarani and Nikravesh [32] developed a contact force model with hysteresis damping for impact in multibody systems. They obtained an expression for the hysteresis damping factor by relating the kinetic energy loss by the impacting bodies to the energy dissipated in the system due to internal damping. The model uses the general trend of the Hertz contact law, in which a hysteresis damping function is

incorporated with the intent to represent the energy dissipated during the impact. The contact force model proposed by Lankarani and Nikravesh can be expressed as [32]

$$F_N = K_{LN} \delta^n \left[1 + \frac{3(1-c_r^2)}{2} \frac{\dot{\delta}}{\dot{\delta}^{(-)}} \right] \quad (5)$$

where the generalized stiffness parameter K_{LN} can be evaluated by Eqs. (3) and (4), c_r represents the coefficient of restitution, $\dot{\delta}$ is the instantaneous relative normal penetration velocity and $\dot{\delta}^{(-)}$ is the initial relative normal impact velocity. The contact force model given by Eq. (5) is valid for the cases in which the dissipated energy during the contact is relatively small when compared to the maximum absorbed elastic energy. Shivaswamy [44] demonstrated that at low impact velocities, the energy dissipation due to internal damping is the main contributor to energy loss.

The contact force models given by Eqs. (2) and (5) are only valid for colliding bodies with ellipsoidal contact areas. For the contact between two parallel cylinders, as in the case of revolute joints with clearance, a literature search has revealed few and approximates force-penetration relations. It is worth nothing that the line contact assumes a precise parallel alignment of the colliding cylinders. Furthermore, a uniform force distribution over the length of the cylinders is also assumed and boundary effects are neglected. For the case of cylindrical contact forces, some authors suggest the use of the more general and straightforward force-penetration relation given by Eq. (5) but with an exponent, n , in the range of 1 to 1.5 [43]. The ESDU-78035 Tribology Series [45] presents some expressions for contact mechanics analysis suitable for engineering applications. For a circular contact area the ESDU-78035 model is the same as the pure Hertz law given by Eq. (2). For a rectangular contact, such as in the case of a pin inside a cylinder, the ESDU-78035 expression for the penetration-contact force is given by

$$\delta = F_N \left(\frac{\sigma_i + \sigma_j}{L} \right) \left[\ln \left(\frac{4L(R_i - R_j)}{F_N(\sigma_i + \sigma_j)} \right) + 1 \right] \quad (6)$$

where $R_{i,j}$ and $\sigma_{i,j}$ are the parameters shown in Eqs. (3) and (4), and L is the length of the cylinder. Since Eq. (6) is a nonlinear implicit function for F_N , with a known penetration depth, F_N can be evaluated. This nonlinear problem requires an iterative scheme, such as the Newton-Raphson method, for solving for the normal contact force, F_N . It must be highlighted that Eq. (6) is purely elastic in nature, that is, it does not account for the energy dissipation during the contact process.

An extension of this force model can be obtained by combining the main features of Eqs. (5) and (6). The fundamental idea of this new and *ad hoc* approach is to use Eq. (6) to compute the generalized stiffness parameter as the slope of the curve $F_N(\delta)$, around the point of instantaneous deformation, that is, K corresponding to a nonlinear stiffness coefficient. In turn, the damping term is evaluated as a combination of ratio between this nonlinear stiffness coefficient by the ESDU-78035 and the stiffness coefficient by Lankarani and Nikravesh approaches. Thus, the combined damping term can be expressed as [26]

$$D_{combined} = D_{LN} \frac{K_{ESDU}}{K_{LN}} \quad (7)$$

where D_{LN} is the damping coefficient derived by Lankarani and Nikravesh [32], K_{ESDU} and K_{LN} are the stiffness coefficients proposed by ESDU-78095 and Lankarani and Nikravesh models, respectively. *It must be stated that the value of the K_{ESDU} is evaluated as the slope of the curve normal contact force versus deformation around the point of instantaneous deformation.* A similar idea has been successfully used in the works by Ravn [31] and Bai and Zhao [17] to investigate mechanical systems with revolute joints with clearance.

It must be noted that there are other candidate models to be considered to compute in intra-joint contact forces in revolute clearance joints within the framework of multibody dynamics. For details, the interested reader is referred to references [46-57].

It is known that the Coulomb law of sliding friction can represent the most fundamental and simplest model of friction between dry contacting surfaces. When sliding takes place, the Coulomb law states that the tangential friction force is proportional to the magnitude of the normal contact force at the contact point by introducing a coefficient of friction. Thus, in this work, the effect of dry friction is modeled according to Coulomb's law, which can be written as

$$F_T = -\frac{\mathbf{v}_T}{|\mathbf{v}_T|} c_f F_N \quad (8)$$

where F_T is the friction force, \mathbf{v}_T is the relative tangential velocity, c_f is the coefficient of friction, and F_N is the normal contact force [25, 29]. It should be mentioned that the friction model must be capable of detecting sliding, sticking and reverse sliding to avoid energy gains during impact. With the continuous analysis method used in this work, detection of stiction is performed during the period of contact. When the relative

tangential velocity of two impacting bodies approaches zero, stiction occurs. Stiction is then controlled as a force balance, i.e., the relative tangential velocity of the two impacting bodies is maintained at zero or a very low value by oscillating forces. Sliding is also possible, however, only present when the normal force is very small and not able to separate the bodies in impact [26].

3. Multibody modeling with a revolute clearance joint

In this section, a brief description of the computational multibody model with a revolute joint with clearance is presented. For this purpose, the commercial MSC.ADAMS software is used [58]. The multibody model selected is the well-known slider-crank mechanism, in which the revolute joint between the connecting rod and slider is modeled as a clearance joint. A general overview of this multibody model is illustrated in Fig. 1, which replicates the original the experimental test rig developed by Lankarani et al. [24] at the Computational Mechanics Laboratory at the National Institute for Aviation Research, Wichita State University, Kansas, USA.

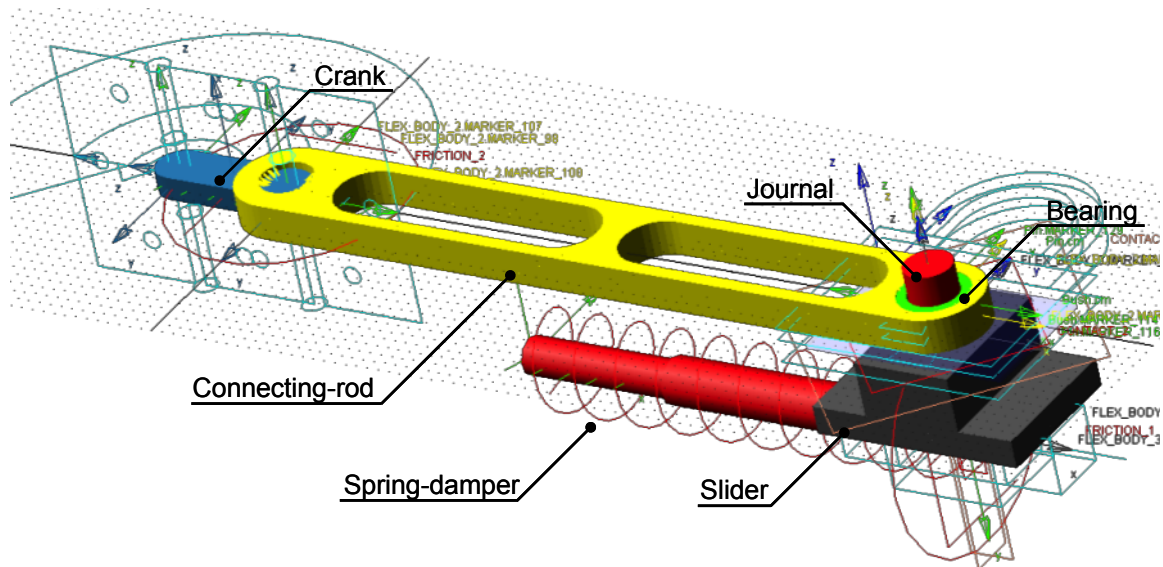

Fig. 1 Multibody model of the slider-crank mechanism developed in MSC.ADAMS

All the bodies present in this multibody model are considered to be rigid and set to have the same inertia and mass properties as the corresponding components of the test rig. The crank, which is the driver element, is connected to the ground by using a revolute joint. The crank and connecting rod are constrained by an ideal revolute joint. In turn, the joint between the slider and connecting rod is model as a clearance revolute joint that is defined using a contact pair between the bearing (in green color) and journal (in red color). It is worth noting that this joint does not impose any kinematic constraint as in the case of ideal joint, but it imposes some forces when the contact between the

journal and bearing surfaces takes place. In the present work, the intra-joint contact forces that develop at this clearance joint are computed by incorporating the constitutive contact force laws, presented in the previous section, in the MSC.ADAMS software. Thus, it is possible to study the effect of using different force models on the system response. ADAMS was configured to use the IMPACT model, which treats contact like a non-linear spring-damper, based on penetration and velocity of penetration, and includes a Coulomb friction model. IMPACT provides a simple Coulomb friction model for tangential friction only, where the coefficient of friction is a function of slip velocity [58]. The disadvantage when using a friction model such as the one represented by Eq. (8), for simulation or control purpose, is the problem of detecting when the relative tangential velocity is zero. A solution for this problem is found in the model proposed by Karnopp, which was developed to overcome the problems with zero velocity detection and to avoid switching between different state equations for sticking and sliding [59]. The drawback with this model is that it is so strongly coupled with the rest of system. The external force is an input to the model and this force is not always explicitly given. Variations of the Karnopp model are widely used since they allow efficient simulations, such as the modified Karnopp model by Centea et al. [60] and the reset integrator model by Haessig and Friedland [61]. In fact, the presence of friction in the contact surfaces makes the contact problem more complicated as the friction may lead to different modes, such as sticking or sliding. For instance, when the relative tangential velocity of two impacting bodies approaches zero, stiction occurs. Indeed, as pointed out by Ahmed et al. [62], the friction model must be capable of detecting sliding, sticking and reverse sliding to avoid energy gains during impact. This work was developed for the treatment of impact problems in jointed open loop multibody systems. Lankarani [63] extends Ahmed formulation to the analysis of impact problems with friction in any general multibody system including both open and closed loop systems.

One of the most critical aspects when dealing with contact problems is the contact detection approach. Initially, the default contact detection library named RAPID for the MSC.ADAMS code was considered [58]. This is a polygon interference detection algorithm implementation [64], which has a good computational performance, albeit at some cost in terms of accuracy. Based on preliminary computational analysis with RAPID library, some numerical instabilities were observed and the outcomes obtained were very unsatisfactory [26]. In order to overcome these difficulties, an alternative library, the PARASOLIDS library, was considered. With this solution a good tradeoff between computational performance and accuracy was observed.

The connecting rod is supported on the slider element using a friction plate, as it is shown in Fig. 2. This plate served to simulate the friction between the connecting rod and the top of the slider in the experimental setup. The slider itself is mounted on a translational joint with friction. It was noticed that the predominant source of resistive force in the test rig linear bearing was not dry friction, but due to the thick lubricant used [26]. This viscosity was simulated by adding a translational spring damper element with the stiffness set to zero. This damping element is represented in Fig. 1.

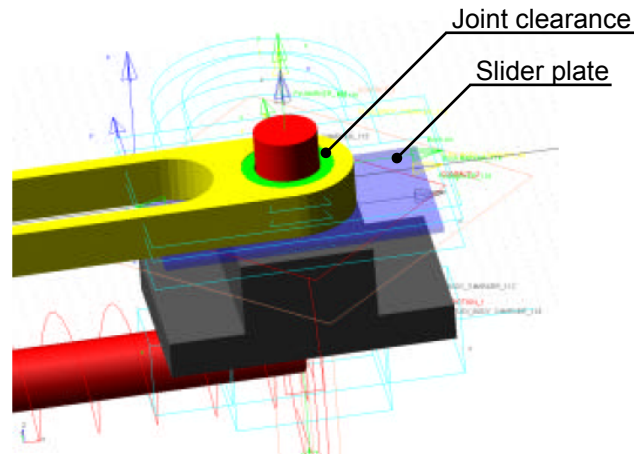

Fig. 2 Slider model with the slider plate

4. Experimental model with a revolute clearance joint

This section briefly describes the experimental test rig constructed with the intent to provide data that can support the identification of different numerical models used to determine the intra-joint contact force developed at the revolute clearance joints. Figure 3 shows an overall view of the experimental apparatus of the slider-crank mechanism, in which the revolute joint that connects the slider and connecting rod has a variable radial clearance [24-26]. This type of joint was chosen due to its simplicity and importance in the field of machines and mechanisms.

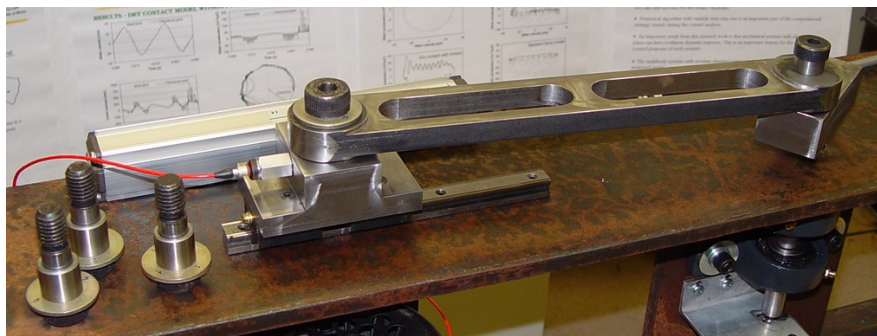

Fig. 3 Experimental slider-crank mechanism

The main sub-assembly of the experimental test rig consists of a slider-crank mechanism with an adjustable radial clearance at the revolute joint between the slider and the connecting rod. This joint was designed as a dry journal-bearing. The remaining kinematic joints were constructed as close to the ideal joints as possible, that is, with minimum clearance and friction in order to minimize any contamination of the data that were intended to be measured. Moreover, these joints were lightly oiled to minimize the friction in their connections. A standard sleeve element was press-fitted to the extremity of the connecting rod, working as bearing, with its diameter fixed to a very tight tolerance. The journal was rigidly connected to the sliding block and incorporates a standard pin with a variable diameter. Thus, the clearance at the test journal-bearing can be altered by simply changing the pin. A particular journal-bearing set was also manufactured in order to simulate an ideal or zero-clearance joint, which is used to obtain the reference data associated with an ideal mechanism. The crankshaft was keyed to the crank and it was supported by ball bearings. A needle bearing, with minimal radial clearance and high rigidity, connects the crank to the connecting rod. The sliding block component is screwed onto a linear translational bearing, which has a precision preloaded system with zero-clearances [24]. Table 1 shows the type of joints used in the experimental slider-crank mechanism and their nominal or operating clearances. Thus, for numerical purposes, they can be considered as ideal or zero-clearance joints [25].

Table 1 Type of joints used in the slider-crank mechanism and the corresponding nominal clearances

Connection	Joint type	Diameter [mm]	Clearance [mm]
Ground – Crank	Ball bearing	17.0	0.009
Crank – Connecting rod	Needle bearing	10.0	0.005
Connecting rod – Slider	Journal-bearing	22.2	0.002
Ground – Slider	Translational bearing	–	0.001

An accelerometer and a linear voltage differential transducer (LVDT) were used to monitor the slider acceleration and displacement, respectively. The slider velocity can be obtained either by performing the numerical integration of the acceleration value, or the numerical differentiation of the displacement data. The impact force between the journal and bearing was measured indirectly, that is, the impact accelerations are directly related to the impact forces.

The slider-crank mechanism works on the horizontal plane and, due to its rigidity and alignment, the gravitational effects on the system's dynamic responses can be neglected. The mechanism components were built entirely from steel and, hence for

practical purposes, were assumed to be perfectly rigid. The connecting rod was built with a hollow cross-section in order to reduce the mass, while maintaining a high stiffness and, thus, reducing the flexibility effects. The slider-crank mechanism and all other mechanical components were mounted on a heavy stiff frame. A summary of the physical properties of the experimental slider-crank model is given in Table 2, where the crank inertia properties include the shaft, encoder, torque sensor and flywheel. Similarly, the slider-block inertia properties take into account the linear bearing and the accelerometer characteristics. The overall mass of the experimental equipment, including frame and moving parts, was about 130 kg [25]. The test rig is used to study the response of the systems for a 1 mm clearance between the connecting rod and the slider.

Table 2 Physical properties of the experimental slider-crank mechanism

Body	Length [m]	Mass [kg]	Moment of inertia [kgm ²]
Crank	0.05	17.900	0.460327
Connecting rod	0.30	1.130	0.015300
Sliding block	-	1.013	0.000772

5. Results and discussion

The main goal of this section is to assess the influence of using of different contact force models on the dynamic response of the slider-crank mechanism. For this purpose, the computational and experimental models presented in the previous sections are utilized. The system is actuated by a motor connected to the crank element, which rotates with a constant angular velocity equal to 177 rpm. The clearance of the revolute joint that connects the slider and connecting rod is 1 mm. Furthermore, the five contact force models described in Section 2 are used to model the interaction between the journal and bearing, which are augmented with the dry Coulomb's friction law. The dynamic behavior of the system is quantified by plotting the linear slider acceleration. The computational and experimental results correspond to four complete crank rotations after the steady state operating regime has been reached.

In the present study a single scenario associated with the relatively low operating input crank speed (177 rpm) is considered in order to ensure that the contacts occur at low or moderate impact velocity, that is, velocities that can not cause plastic deformation. When the collisions between the journal and bearing surfaces takes place at high impact velocity, plastic or permanent will occur and, consequently, the contact force models considered in this study can not be utilized since they are only valid for elastic domain [37, 65-67]. In fact, the contact force models described are only valid for

impact velocities lower than the propagation velocity of elastic waves across the bodies, i.e., $\delta^{(-)} \leq 10^{-5} \sqrt{\frac{E}{\rho}}$. The quantity $\sqrt{\frac{E}{\rho}}$, velocity of wave propagation, is the larger of two propagation velocities of the elastic deformation waves in the colliding bodies, where E is the Young modulus and ρ is the material mass density [68]. Therefore, impacts at higher velocities, exceeding the propagation velocity of the elastic deformation waves, are likely to dissipate energy in a form of permanent indentation. In addition, it is well known that the value of the coefficient of restitution depends on the impact velocity [69]. However, for relatively low or moderate impact velocities, the value of the coefficient of restitution does not vary in a significant manner and can be assumed to be constant, as it is the case of present work. The interested reader in the details on these issues is referred to the works by Shivaswamy and Lankarani [37], Minamoto and Kawamura [52] and Yigit et al. [53].

Figure 4 depicts the linear slider acceleration evolution when the linear Hooke force law is utilized. From the curve diagrams of Fig. 4, it is clear that this pure elastic nature of the contact force model produces very high peaks in terms of the slider accelerations when compared with the experimental data. In fact, the slider acceleration waveforms obtained from computational simulation are significantly different from those obtained experimentally, as the peak is 15 times greater. Moreover, it can also be observed that with this approach, there is no continuous or permanent contact between the journal and bearing surfaces, that is, there is a rebound after each impact. However, it should be noticed that, in general, there is a replicable response for each crank rotation. These observations are not surprising in the measure that this linear Hooke law is only valid for very low impact velocities and very elastic contacts [30].

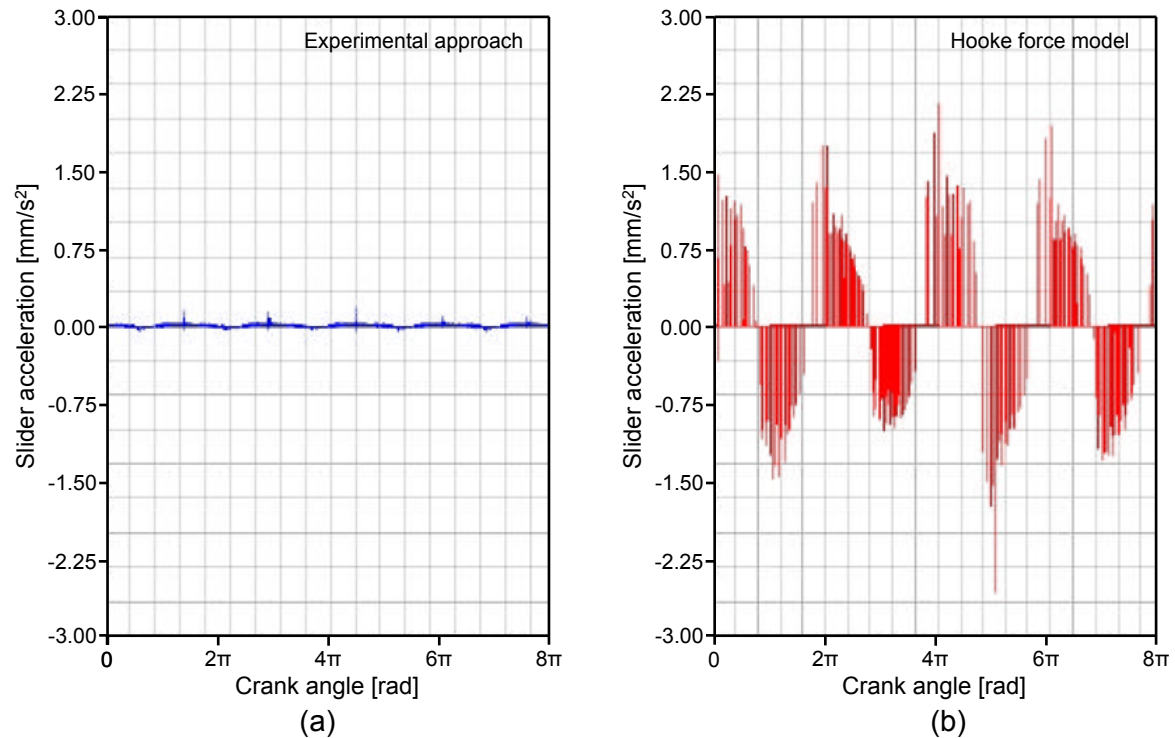

Fig. 4 Time history of the linear slider accelerations: (a) Experimental data; (b) Computational results when Hooke contact law is used

In a similar manner, the outcomes from the Hertz and ESDU-78035 contact force models exhibit the same evolution, but the slider acceleration peaks are lower when compared with the Hooke's law, as illustrated in Figs. 5 and 6. Again, the waveforms of the slider acceleration is different from the experimental data, and the acceleration appears to be imparted as a series of frequent, sharp, short-duration impacts. The peak slider acceleration for the Hertz and ESDU-78035 are, respectively, more than 6 and 2 times those obtained from experimental tests. This is not surprising since these two contact force models are still elastic in nature, but can be useful for low impact velocities. It should be noticed that when the ESDU-78035 contact force approach is utilized, the system's behavior is not periodic in the measure that the slider acceleration plots are not repeatable for each crank rotation, as observed from Fig. 6. Taking into account the significant improvements in terms of the reduction of the acceleration peaks, it is reasonably that the inclusion of the damping terms to the contact approach will improve the performance of the model's response in terms of the correlation between the experimental and computational results.

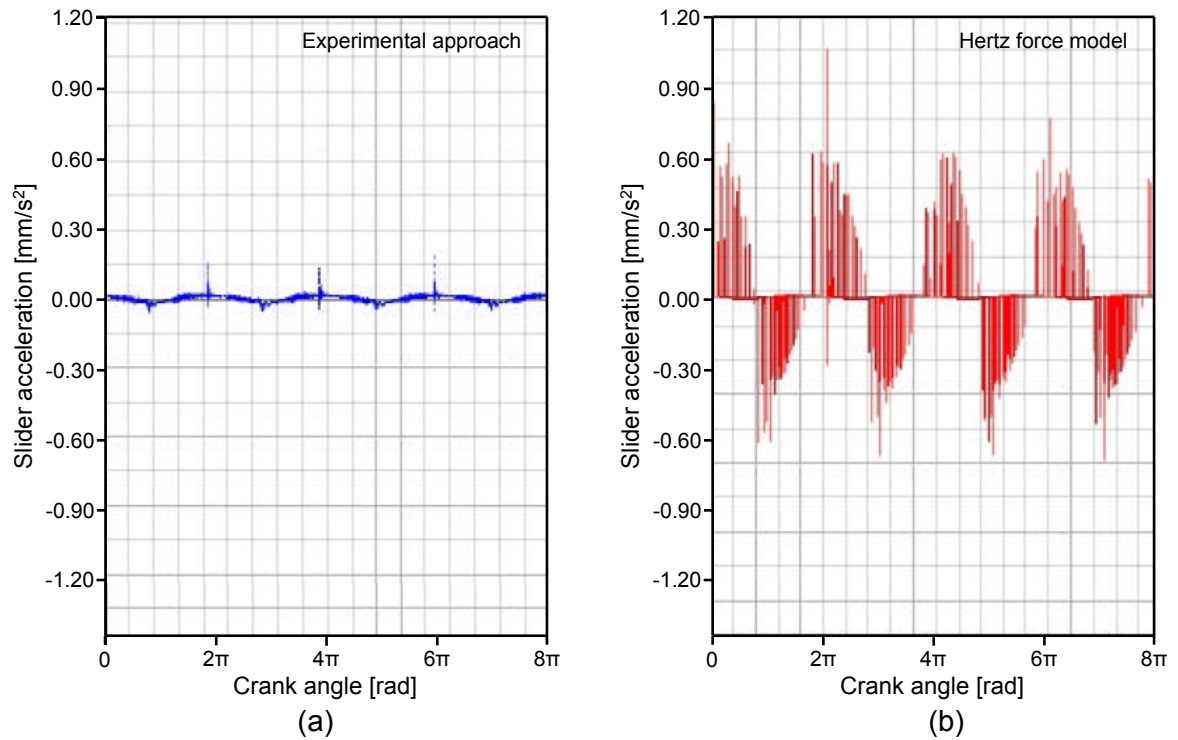

Fig. 5 Time history of the linear slider accelerations: (a) Experimental data; (b) Computational results when Hertz contact law is used

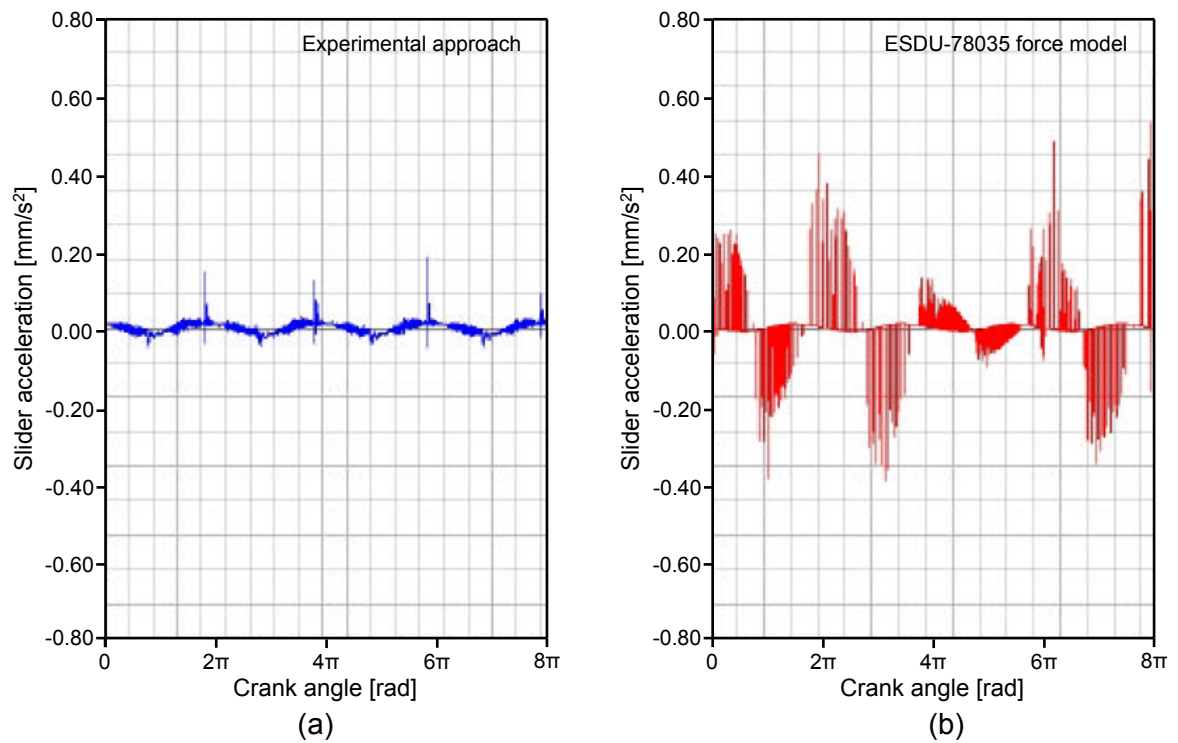

Fig. 6 Time history of the linear slider accelerations: (a) Experimental data; (b) Computational results when ESDU-78035 contact approach law is used

Figures 7 and 8 show the slider acceleration evolutions when the Lankarani and Nikravesh contact force and the combined force approach given by Eqs. (5)-(7) are

considered, respectively. It should be noted that with these two formulations, the obtained results match reasonably well with the experimental data, in particular for the combined case utilizing combined damping term given by Eq. (7). This is not surprising since these two approaches include some damping in terms of the restitution coefficient, as Eq. (5) explicitly shows. Figure 7 clearly shows that the Lankarani and Nikravesh force model provides some significant improvements over the pure elastic force laws. This might be taken as an indicator that damping does indeed play a crucial role in these types of contact events. The predicted peak values are a little higher than the experimental ones. This fact can be associated with the punctual (sphere-to-sphere) nature of the contact geometry. This drawback is overcome by observing the plots of Fig. 8, in which the combined force approach and experimental data match quite well. It must be highlighted that the combined approach utilized the ESDU tribology-based rectangular contact idea together with the damping term proposed by Lankarani and Nikravesh [32].

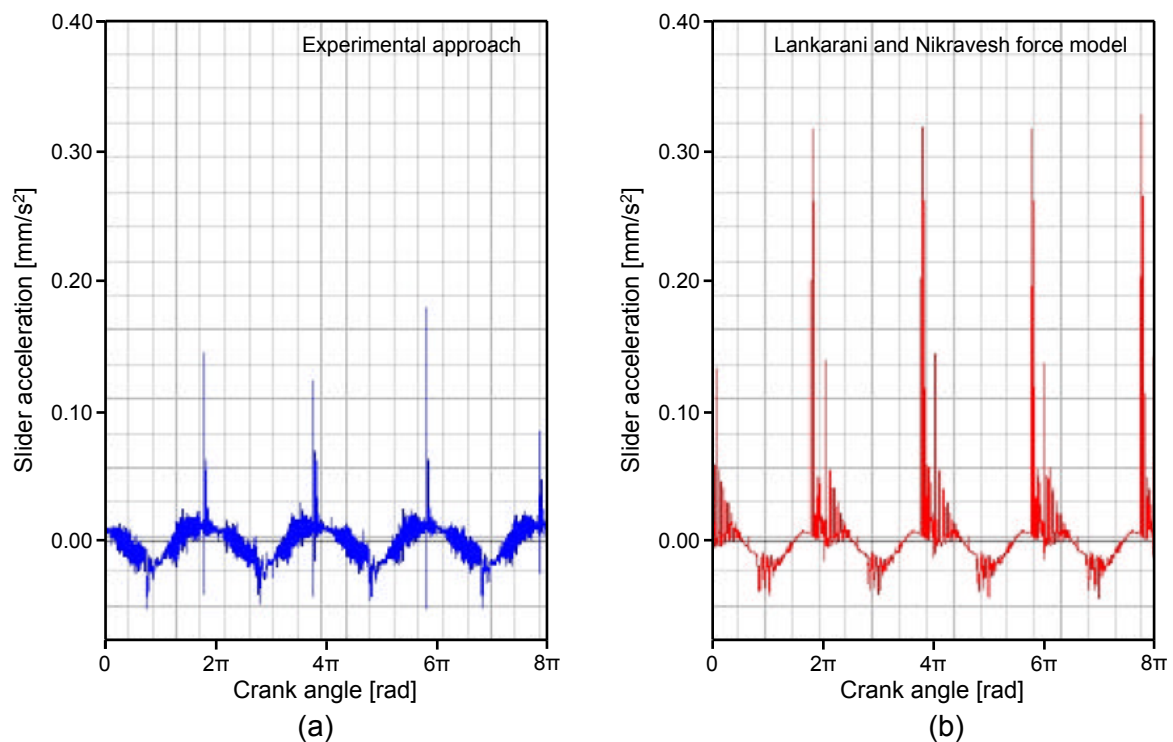

Fig. 7 Time history of the linear slider accelerations: (a) Experimental data; (b) Computational results when Lankarani and Nikravesh contact law is used

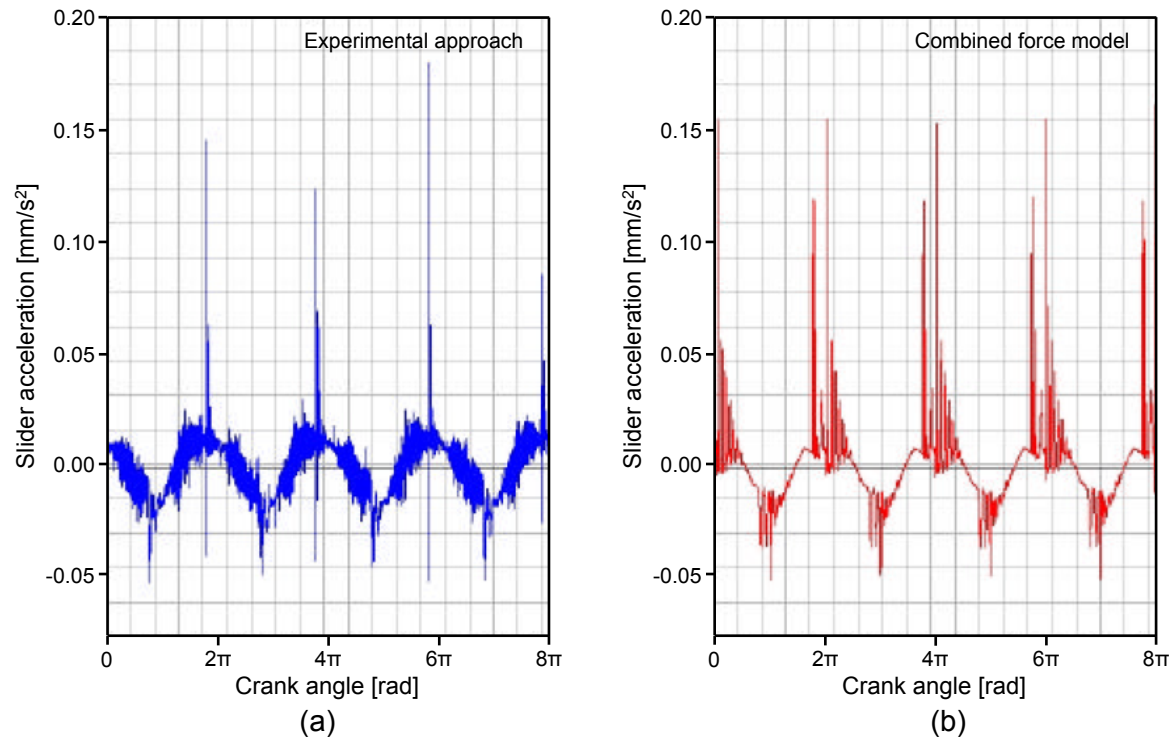

Fig. 8 Time history of the linear slider accelerations: (a) Experimental data; (b) Computational results when the combined force contact model is used

6. Conclusions

A computational and experimental study of the effect of contact force on the dynamic response of multibody systems with revolute clearance joints has been presented in the paper. In the sequel of this process, the fundamental issues of the most relevant elastic and dissipate force models were revisited. Special attention was given to the Hertzian contact theory and to the ESDU Tribology-based approach for cylindrical contacts. A complete description of a computational multibody model of a slider-crank mechanism was presented. For this purpose, the MSC.ADAMS commercial software was utilized. In addition, a brief characterization of the experimental setup of the slider-crank mechanism was offered.

The computational and experimental tests performed were conducted by considering a revolute clearance joint between the connecting rod and slider. The intra-joint contact forces developed during the contact-impact phases were evaluated by employing several different elastic and dissipative force models described in this work. An *ad hoc* approach was used to evaluate the system's combined damping from the stiffness values from the ESDU tribology-based model and the Hertzian-based Lankarani and Nikravesh model. Based on the general results obtained from computational and experimental analysis it was observed that the ESDU tribology-

based contact force model with the *ad hoc* damping provided results that reasonably matched experimental test results. Overall, it can be concluded that selection of the appropriate force model together with the dissipative term plays a crucial role in the dynamic behavior of multibody systems involving contact events. This issue is particularly relevant when the systems operate at low or moderate impact velocities and low coefficient of restitution.

Acknowledgments

This work is supported by the Portuguese Foundation for the Science and Technology (FCT) under the research project BIOJOINTS (PTDC/EME-PME/099764/2008). The second author expresses his gratitude to Portuguese Foundation for the Science and Technology for the postdoctoral scholarship (SFRH/BPD/77831/2011).

References

1. Ravn, P., Shivaswamy, S., Alshaer, B.J., Lankarani, H.M.: Joint clearances with lubricated long bearings in multibody mechanical systems. *Journal of Mechanical Design*, 122, 484-488 (2000)
2. Flores, P., Lankarani, H.M., Ambrósio, J., Claro, J.C.P.: Modelling lubricated revolute joints in multibody mechanical systems. *Proceedings of the Institution of Mechanical Engineers, Part-K Journal of Multi-body Dynamics*, 218(4) 183-190 (2004)
3. Flores, P., Ambrósio, J., Claro, J.C.P., Lankarani, H.M.: Dynamic behaviour of planar rigid multibody systems including revolute joints with clearance. *Proceedings of the Institution of Mechanical Engineers, Part-K Journal of Multi-body Dynamics*, 221(2), 161-174 (2007)
4. Flores, P., Ambrósio, J., Claro, J.C.P., Lankarani, H.M.: Translational joints with clearance in rigid multibody systems. *Journal of Computational and Nonlinear Dynamics*, 3(1), 0110071-10 (2008)
5. Erkaya, S., Uzmay, I.: Investigation on effect of joint clearance on dynamics of four-bar mechanism. *Nonlinear Dynamics*, 58, 179-198 (2009)
6. Erkaya S., Uzmay, İ.: Determining link parameters using genetic algorithm in mechanisms with joint clearance. *Mechanism and Machine Theory*, 44, 222-234 (2009)
7. Flores, P.: Modeling and simulation of wear in revolute clearance joints in multibody systems. *Mechanism and Machine Theory*, 44(6), 1211-1222 (2009)
8. Tian, Q., Zhang, Y., Chen, L., Yang, J.: Simulation of planar flexible multibody systems with clearance and lubricated revolute joints. *Nonlinear Dynamics*, 60, 489-511 (2010)
9. Flores, P., Lankarani, H.M.: Spatial rigid-multi-body systems with lubricated spherical clearance joints: modeling and simulation. *Nonlinear Dynamics*, 60, 99-114 (2010)
10. Brutti, C., Coglitore, C., Valentini, P.P.: Modeling 3D revolute joint with clearance and contact stiffness, *Nonlinear Dynamics*, 66(4), 531-548, (2011)
11. Tian, Q., Liu, C. Machado, M., Flores, P.: A new model for dry and lubricated cylindrical joints with clearance in spatial flexible multibody systems. *Nonlinear Dynamics*, 64, 25-47 (2011)

12. Liu, C., Tian, Q., Hu, H.: Dynamics and control of a spatial rigid-flexible multibody system with multiple cylindrical clearance joints. *Mechanism and Machine Theory*, 52, 106-129 (2012)
13. Flores, P., Lankarani, H.M.: Dynamic response of multibody systems with multiple clearance joints. *Journal of Computational and Nonlinear Dynamics*, 7(3), 031003, 13p, (2012)
14. Erkaya, S.: Prediction of vibration characteristics of a planar mechanism having imperfect joints using neural network. *Journal of Mechanical Science and Technology*, 26(5), 1419-1430 (2012)
15. Erkaya, S., Uzmay, I.: Effects of balancing and flexibility on dynamics of a planar mechanism having joint clearance. *Scientia Iranica B*, 19(3), 483-490 (2012)
16. Olyaei, A.A., Ghazavi, M.R.: Stabilization slider-crank mechanism with clearance joints. *Mechanism and Machine Theory*, 53, 17-29 (2012)
17. Bai, Z.F., Zhao, Y.: Dynamics modeling and quantification analysis of multibody systems including revolute clearance joints. *Precision Engineering*, 36, 554-567 (2012)
18. Bai, Z.F., Zhao, Y.: Dynamic behaviour analysis of planar mechanical systems with clearance in revolute joints using a new hybrid contact force model. *International Journal of Mechanical Sciences*, 54, 190-205 (2012)
19. Muvengei, O., Kihui, J., Ikuu, B.: Numerical study of parametric effects on the dynamic response of planar multi-body systems with differently located frictionless revolute clearance joints. *Mechanism and Machine Theory*, 53, 30-49 (2012)
20. Chaker, A., Mlika, A., Laribi, M.A., Romdhane, L., Zegloul, S.: Clearance and manufacturing errors' effects on the accuracy of the 3-RCC spherical parallel manipulator. *European Journal of Mechanics A/Solids*, 37, 86-95 (2013)
21. Haines, R.S.: Survey: 2-Dimensional motion and impact at revolute joints. *Mechanism and Machine Theory*, 15, 361-370, (1980)
22. Flores, P.: A parametric study on the dynamic response of planar multibody systems with multiple clearance joints. *Nonlinear Dynamics*, 61(4), 633-653 (2010)
23. Soong, K. Thompson, B.S.: A theoretical and experimental investigation of the dynamic response of a slider-crank mechanism with radial clearance in the gudgeon-pin joint. *Journal of Mechanical Design*, 112, 183-189 (1990)
24. Lankarani, H.M., Koshy, S., Kanetkar, G., Flores, P., Claro, J.C.P., Ambrósio, J.: Experimental study on multibody systems with clearance joints. *The Second Asian Conference on Multibody Dynamics 2004*, Olympic Parktel, Seoul, Korea, August 1-4, 6 p. (2004)
25. Flores, P., *Dynamic Analysis of Mechanical Systems with Imperfect Kinematic Joints*. Ph.D. Dissertation, University of Minho, Guimarães, Portugal (2004)
26. Koshy, C.S., 2006, *Characterization of Mechanical Systems with Real Joints and Flexible Links*. Ph.D. Dissertation, Wichita State University, Wichita, Kansas, USA (2006)
27. Khemili, I., Romdhane, L.: Dynamic analysis of a flexible slider-crank mechanism with clearance. *European Journal of Mechanics A/Solids* 27(5), 882-898 (2008)
28. Erkaya, S., Uzmay, I.: Experimental investigation of joint clearance effects on the dynamics of a slider-crank mechanism. *Multibody System Dynamics*, 24, 81-102 (2010)
29. Flores, P., Koshy, C.S. Lankarani, H.M., Ambrósio, J., Claro, J.C.P.: Numerical and experimental investigation on multibody systems with revolute clearance joints. *Nonlinear Dynamics*, 65(4), 383-398 (2011)
30. Machado, M., Moreira, P., Flores, P., Lankarani, H.M.: Compliant contact force models in multibody dynamics: evolution of the Hertz contact theory. *Mechanism and Machine Theory*, 53, 99-121 (2012)

31. Ravn, P.: Analysis and Synthesis of Planar Mechanical Systems Including Flexibility, Contact and Joint Clearance. Ph.D. Dissertation, DCAMM Report No. S78, Technical University of Denmark, Lyngby, Denmark (1998)
32. Lankarani, H.M., Nikravesh, P.E.: A contact force model with hysteresis damping for impact analysis of multibody systems. *Journal of Mechanical Design*, 112, 369-376 (1990)
33. Shigley, J.E., Mischke, C.R.: *Mechanical Engineering Design*, McGraw-Hill, New York (1989)
34. Timoshenko, S.P., Goodier, J.N.: *Theory of Elasticity*. McGraw Hill, New York (1970)
35. Johnson, K.L.: One hundred years of Hertz contact. *Proceedings of the Institution of Mechanical Engineers*, 196, 363-378 (1982)
36. Hertz, H.: Über die Berührung fester elastischer Körper, *Journal reine und angewandte Mathematik*, 92, 156-171 (1881)
37. Shivaswamy, S., Lankarani, H.M.: Impact analysis of plate using quasi-static approach. *Journal of Mechanical Design*, 119, 376-381 (1997)
38. Cross, R.: The bounce of a ball. *American Journal of Physics*, 67, 222-227 (1999)
39. Dietl, P., Wensing, J., van Nijen, G.C.: Rolling bearing damping for dynamic analysis of multi-body systems - experimental and theoretical results. *Proceedings of the Institution of Mechanical Engineers, Part K: Journal of Multi-body Dynamics*, 214(1), 33-43 (2000)
40. Pereira, C.M., Ramalho, A.L., Ambrósio, J.A.: A critical overview of internal and external cylinder contact force models. *Nonlinear Dynamics*, 63, 681-697 (2011)
41. Goldsmith, W.: *Impact - The Theory and Physical Behaviour of Colliding Solids*. Edward Arnold Ltd, London, England (1960)
42. Machado, M., Flores, P., Claro, J.C.P., Ambrósio, J., Silva, M., Completo, A., Lankarani, H.M.: Development of a planar multi-body model of the human knee joint. *Nonlinear Dynamics*, 60, 459-478 (2010)
43. Hunt, K.H., Crossley, F.R.E.: Coefficient of restitution interpreted as damping in vibroimpact. *Journal of Applied Mechanics*, 7, 440-445 (1975)
44. Shivaswamy, S.: *Modeling Contact Forces and Energy Dissipation During Impact in Multibody Mechanical Systems*, Ph.D. Dissertation, Wichita State University, Wichita, Kansas, USA (1997)
45. ESDU 78035 Tribology Series, Contact Phenomena. I: Stresses, Deflections and Contact Dimensions for Normally Loaded Unlubricated Elastic Components. *Engineering Sciences Data Unit*, London, England (1978)
46. Dubowsky, S., Freudenstein, F.: Dynamic analysis of mechanical systems with clearances, Part 1: Formulation of dynamic model. *Journal of Engineering for Industry*, 93, 305-309 (1971)
47. Herbert, R.G., McWhannell, D.C.: Shape and frequency composition of pulses from an impact pair. *Journal of Engineering for Industry*, 99, 513-518 (1977)
48. Lee, T.W., Wang, A.C.: On the dynamics of intermittent-motion mechanisms, Part 1: Dynamic model and response. *Journal of Mechanisms, Transmissions, and Automation in Design*, 105, 534-540 (1983)
49. Kuwabara, G., Kono, K.: Restitution coefficient in a collision between two spheres. *Japanese Journal of Applied Physics*, 26, 1230-1233 (1987)
50. Gonthier, Y., McPhee, J., Lange, C., Piedboeuf, J-C.: A regularized contact model with asymmetric damping and dwell-time dependent friction. *Multibody System Dynamics*, 11, 209-233 (2004)

51. Flores, P., Machado, M., Silva, M.T., Martins, J.M.: On the continuous contact force models for soft materials in multibody dynamics. *Multibody System Dynamics*, 25, 357-375 (2011)
52. Minamoto, H., Kawamura, S.: Moderately high speed impact of two identical spheres. *International Journal of Impact Engineering*, 38, 123-129 (2011)
53. Yigit, A.S., Christoforou, A.P., Majeed, M.A.: A nonlinear visco-elastoplastic impact model and the coefficient of restitution. *Nonlinear Dynamics*, 66, 509-521 (2011)
54. Roy, A., Carretero, J.A.: A damping term based on material properties for the volume-based contact dynamics model. *International Journal of Non-Linear Mechanics*, 47(3), 103-112 (2012)
55. Gharib, M., Hurmuzlu, Y., A new force model for low coefficient of restitution impact. *Journal of Applied Mechanics*. 79(6), 064506, 5p, (2012)
56. Boss, M., McPhee, J.: Volumetric modelling and experimental validation of normal contact dynamic forces. *Journal of Computational and Nonlinear Dynamics*, 8, 021006, 8p. (2013)
57. Khulief, Y.A.: Modeling of impact in multibody systems: An overview. *Journal of Computational and Nonlinear Dynamics*, 8, 021012, 15p, (2013)
58. MSC.Software, MSc.ADAMS ®, Release R3, Help System (2008)
59. Karnopp, D.: Computer Simulation of Stick-Slid Friction in Mechanical Dynamic Systems. *Journal of Dynamic Systems, Measurement, and Control*, 107, 100-103 (1985).
60. Centea, D., Rahnejat, H., Menday, M.T.: Non-linear multi-body dynamic analysis for the study of clutch torsional vibrations (judder). *Applied Mathematical Modelling*, 25, 177-192 (2001)
61. Haessig, D.A., Friedland, B., On the Modelling and Simulation of Friction. *Journal of Dynamic Systems, Measurement, and Control*, 113, 354-362 (1991)
62. Ahmed, S., Lankarani, H.M., Pereira, M.F.O.S.: Frictional Impact Analysis in Open Loop Multibody Mechanical System. *Journal of Mechanical Design*, 121, pp. 119 127 (1999)
63. Lankarani, H.M.: A Poisson Based Formulation For Frictional Impact Analysis of Multibody Mechanical Systems With Open or Closed Kinematic Chains. *Journal of Mechanical Design*, 115, 489-497 (2000)
64. Gottschalk, S., Lin, M.C., Manocha, D.: OBBTree: A hierarchical structure for rapid interference detection. *Proceedings of the 23rd Annual Conference on Computer Graphics and Interactive Techniques*, 171-180 (1996)
65. Johnson, K.L.: *Contact mechanics*. Cambridge University Press (1985)
66. Stronge, W.J.: *Impact mechanics*. Cambridge University Press, Cambridge, (2000)
67. Lankarani, H.M., Nikravesh, P.E.: Continuous contact force models for impact analysis in multibody systems. *Nonlinear Dynamics*, 5, 193-207 (1994)
68. Love, A.E.H., *A Treatise on the mathematical theory of elasticity*. Fourth edition, Dover Publications, New York (1944)
69. Seifried, R., Schiehlen, W., Eberhard, P.: The role of the coefficient of restitution on impact problems in multi-body dynamics, *Proceedings of the Institution of Mechanical Engineers, Part K: Journal of Multi-body Dynamics*, 224, 279-306 (2010)